

1 Utilizzo

Prodotto da GRUPPO STAMPLAST questo articolo è indicato per la stesura di malte cementizie. Disponibile in diverse misure.



FR30X42-01
 Frattone plastica 30x42

2 Modelli

Materiali
 Polistirolo

COD.	MOD.*					
FR30X42-01	Frattone plastica 30x42	●	15	630	100x120x225	0,610 kg/pz

*MEASURES IN CENTIMETERS

Colori



3 Caratteristiche tecniche

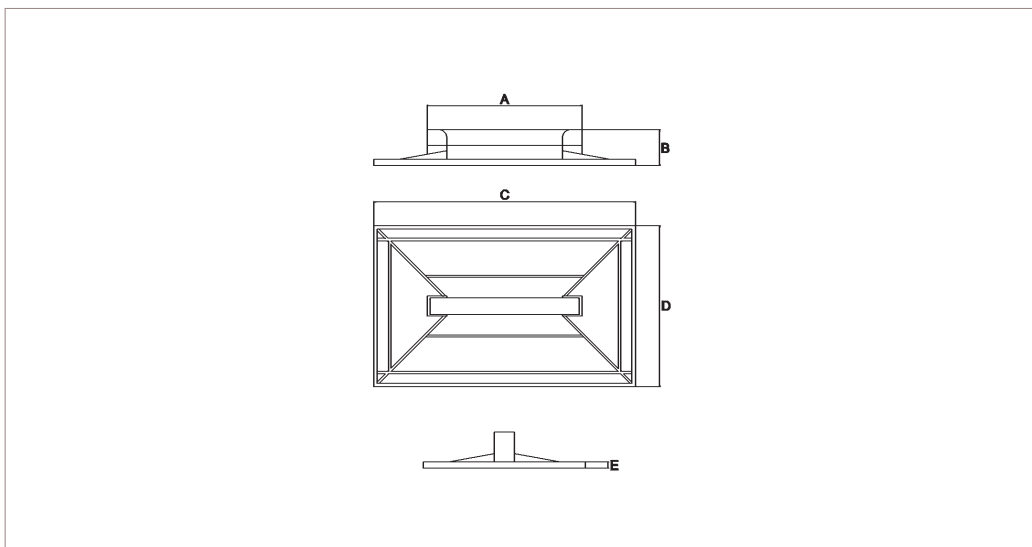

MOD.	A*	B*	C*	D*	E*
Frattone plastica 30x42	250	58	420	300	11

*MEASURES IN MILLIMETERS

frattone con manico in plastica_30x42